



SPHERE™

E-Series

Installation Manual

Click Wheel Keypad

KLK-E5

Premier products for Russound
Sphere™ Certified Professionals

R Russound®

SAFETY INSTRUCTIONS

For your safety, please read and follow these precautions before installing or using this product:

1. Read instructions. Read and understand all the applicable instructions before installing or operating the product.
2. Retain instructions. Keep this manual in a convenient place for reference.
3. Heed warnings. Be aware and heed all warnings on the product and in the instructions.
4. Follow instructions. Install and use this product only as described in the instructions. Don't try to use this product in ways for which it wasn't designed.
5. Use indoors only. Don't expose this product to the weather or harsh environmental conditions such as continuous sunlight, excessive humidity, or rain.
6. Keep product dry. Don't use the product near water; for example, near a bathtub, washbowl, kitchen sink, laundry tub, in a wet basement, or near a swimming pool. Also, do not handle the product when your hands are wet or damp.
7. Use the right power source. Don't connect the product directly to electrical line voltage. Use only the power adapter provided with the product, described in the operating instructions, or as marked on the product.
8. Ground product properly. Make sure the product's means of grounding or polarization is not defeated.
9. Power cord protection. Power supply cords should be routed so that they are not likely to be walked on or pinched by items placed upon or against them, paying particular attention to cords at plugs, receptacles, and the point where they exit from the appliance.
10. Keep product clean. From time to time, wipe off the product with a clean soft cloth. Don't use abrasive materials, thinners, alcohol or other chemical solvents or materials.
11. Avoid spills and foreign objects. Make sure liquids and objects don't get into the product enclosure through any openings.
12. Get professional service. Have the product serviced only by qualified service personnel when:
 - The power supply cord/plug has been damaged
 - Liquids spilled/objects have fallen into the product
 - The product has been exposed to rain
 - The product doesn't appear to operate normally
 - The product is damaged
13. Don't attempt to service the product yourself. Doing so will void the warranty.

If you have any questions, call Russound at 1.800.638.8055 or 603.659.5170.



Conforms to
UL60065
Certified to
CAN/CSA
IEC60065

TABLE OF CONTENTS

| | | | |
|-------------------------------------|----|------------------------------------|----|
| Product Overview | 4 | Rear Panel AUX Connection..... | 11 |
| KLK-E5 Front Panel | 5 | Keypad Navigation and Menus | 12 |
| KLK-E5 Rear Panel..... | 6 | Set System Time and Date..... | 13 |
| External IR Connection..... | 7 | Authorize Support for ACA-E5 | 14 |
| IR Receiver Disable Jumper | 8 | Technical Specifications..... | 15 |
| KLK-E5 Installation..... | 9 | Warranty..... | 15 |
| ACA-E5 Keypad Port Connections..... | 10 | | |

PRODUCT OVERVIEW

The KLK-E5 keypad is a beautiful wall-mounted interface for the ACA-E5 controller system. It features a grayscale screen and touch wheel to easily navigate menus, settings and source features.

This double-gang keypad offers a touch-sensitive ring for source selection and menu navigation, and responsive hard buttons for most-often used commands. It also supports IR reception for use with a remote control. It provides audible feedback and a detailed display of source activity.

The grayscale LCD screen displays realtime information such as Playlist, Channel, Station, Artist, Song Title, Genre and more.

The KLK-E5 is designed to control an ACA-E5 RNET audio-video distribution system. It controls Russound sources, including the SMS3 Smart Media Server, iBridge™ Dock, and the ST2 Tuner with AM/FM and/or satellite radio.

Most controller and source setup functions are performed through SCS-E5 programming software; however, a few installation steps are completed through the KLK-E5 menus, including setting time and date, keypad brightness and contrast, and adjusting room audio properties. The KLK-E5's installation screen provides a gateway for online support for the system when needed.

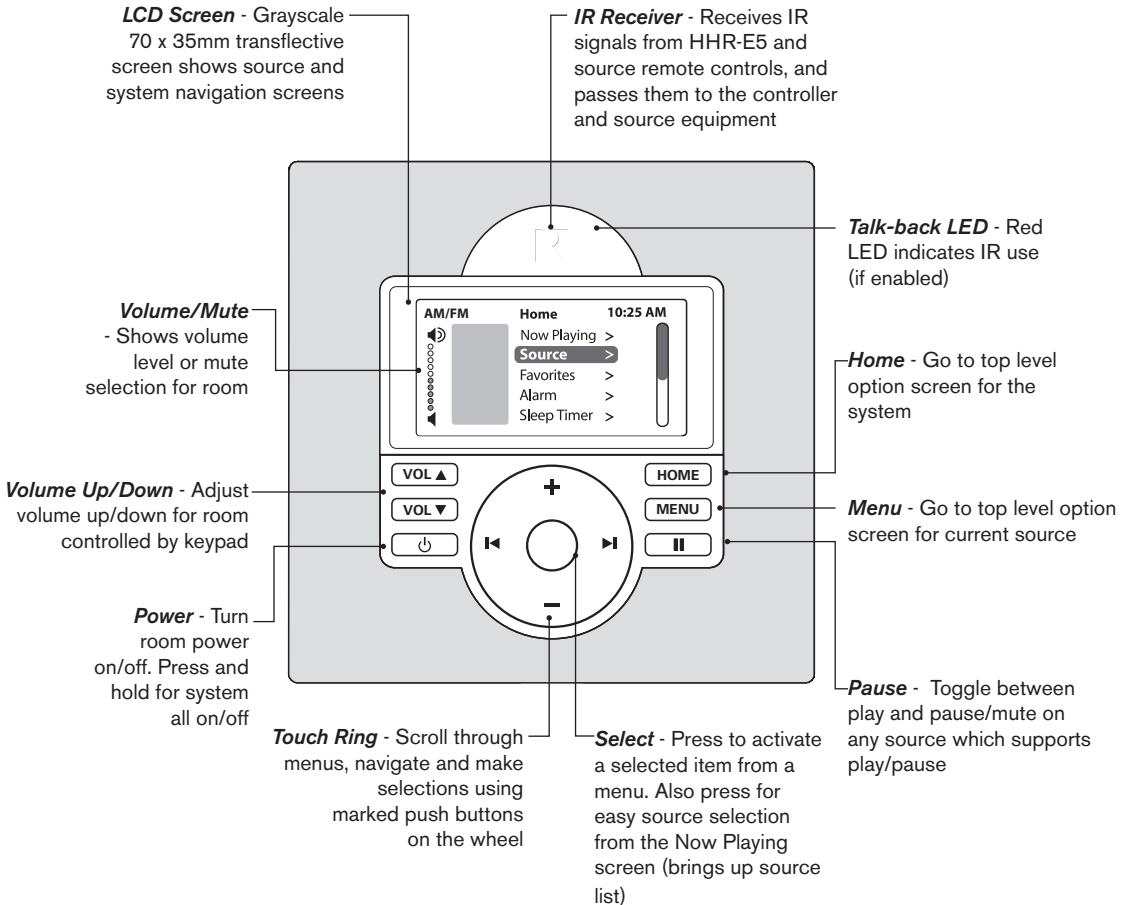

KLK-E5 REAR PANEL

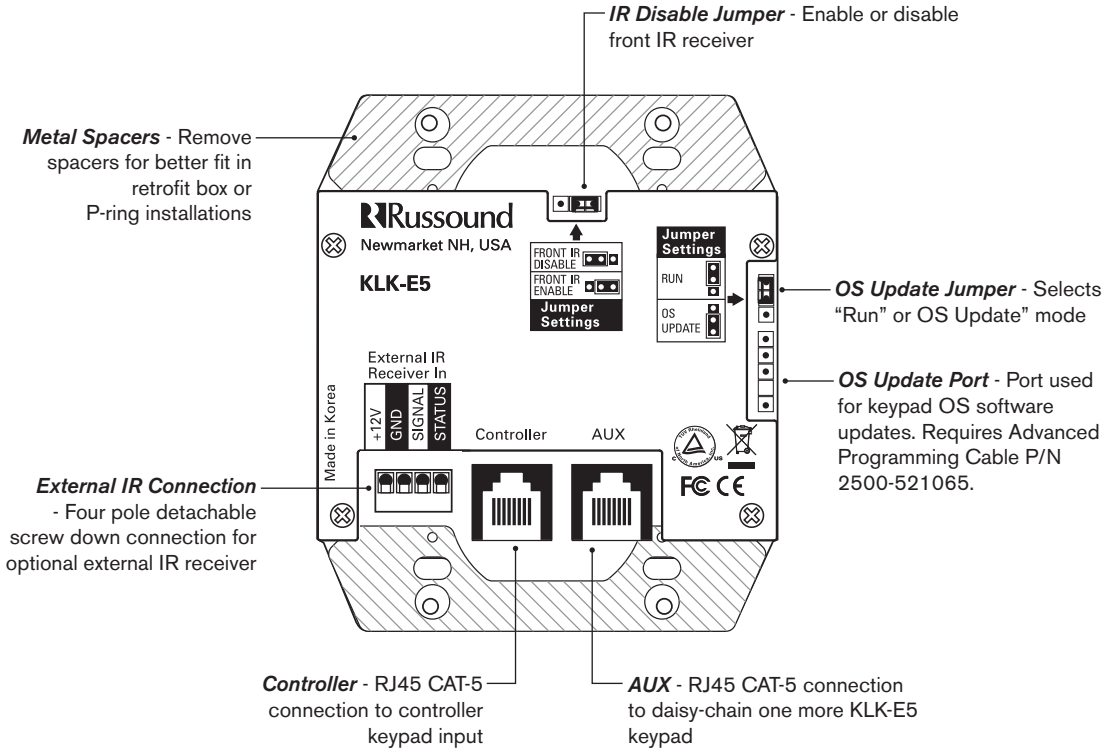

KLK-E5 EXTERNAL IR CONNECTION

The KLK-E5 keypad has an External IR Receiver In terminal for connecting an external IR Receiver such as the Russound 858, SaphIR 862 Eye, or SaphIR 860 Phantom.

Use 2 twisted pair wire with one pair connecting GND (GROUND) and IR (SIGNAL) and the other pair connecting ST (STATUS) and V+ (+12VDC).

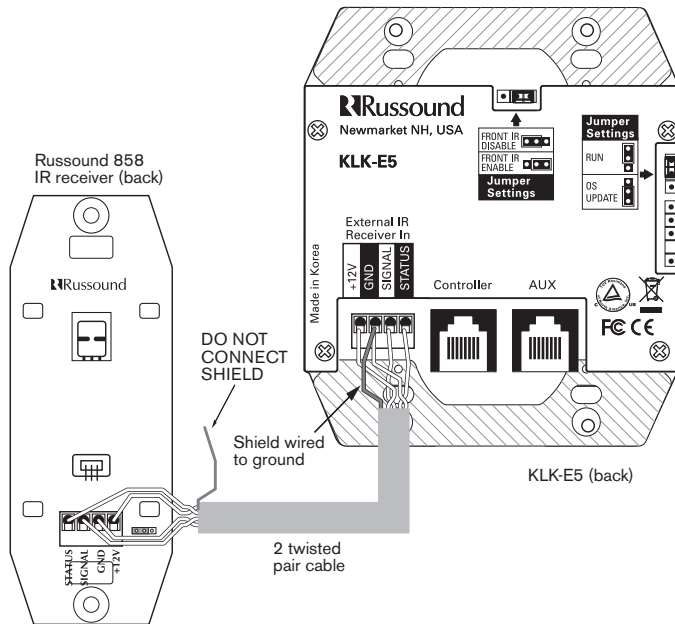

KLK-E5 IR RECEIVER DISABLE JUMPER

The KLK-E5 keypad has a jumper that allows you to disable the front IR receiver. This may be useful in settings where the KLK may be exposed to a lot of stray IR, when using an external IR receiver, or if you don't need to use a remote control for that keypad.

To disable the front IR receiver, move the jumper to cover the left two pins. To enable, cover the right two pins with the jumper.

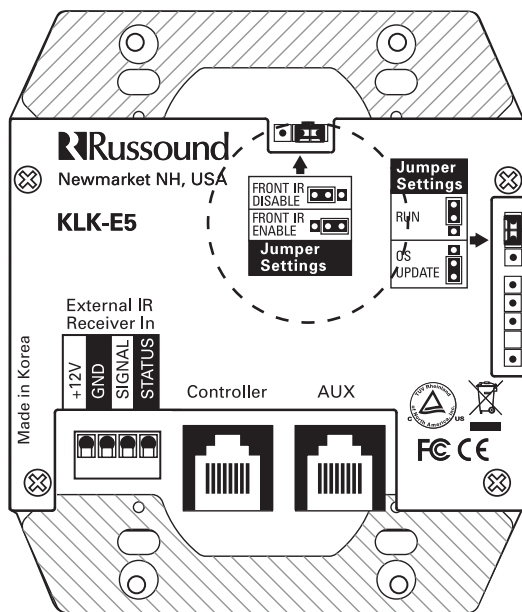

CAUTION:

Mounting screws must be hand-tightened. Over-tightening the mounting screws can cause the touch ring and hard buttons to jam and malfunction.

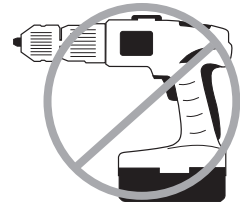

For best viewing and usage, the KLK-E5 should be mounted at thermostat height, or about 59" from the floor.

To install a double-gang keypad, you will need a UL/CSA approved plastic 32ci double-gang wall box. Attach the box to the wall with appropriate fasteners.

For installations employing a retrofit box or P-ring, the two metal spacers on the back of the keypad's bezel can be removed for a better fit.

Route CAT-5 wire to the wall box from the controller. There should be not more than 250 feet of CAT-5 cable between the keypad and the controller.

Terminate the CAT-5 cable with an RJ45 connector, using the T568A wiring standard. Insert the RJ45 connector into the jack marked "Controller" on the back of the keypad.

Mount the keypad in the wall box and attach the cover plate. Repeat the steps until all keypads are installed.

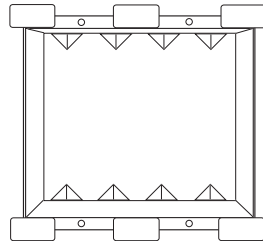
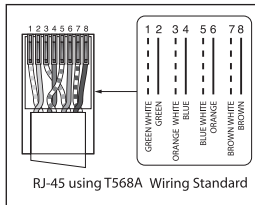

Double-gang wall box

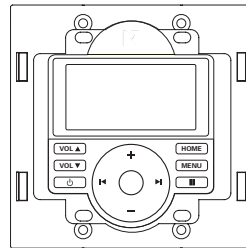

KLK-E5 keypad

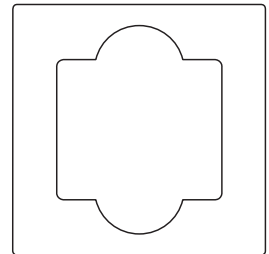

Cover plate

KLK-E5 KEYPAD PORT CONNECTIONS

The KLK-E5 keypad is designed for use with the ACA-E5 controller, and connects to the keypad port on the back of the controller. The ACA-E5 has eight keypad ports.

Connect the keypad to the controller keypad input with CAT-5 cable using RJ45 connector with T568A wiring standard. Cable length from the keypad back to the controller should be no more that 250 feet.

If more keypads are desired for a zone, use an optional SA-ZX3 keypad splitter with a 12VDC 1A power supply at the controller end. All keypads on an SA-ZX3 control the same zone and need to be assigned the same zone ID.

More detailed information regarding SA-ZX3 installation and operation can be found in its installation manual.

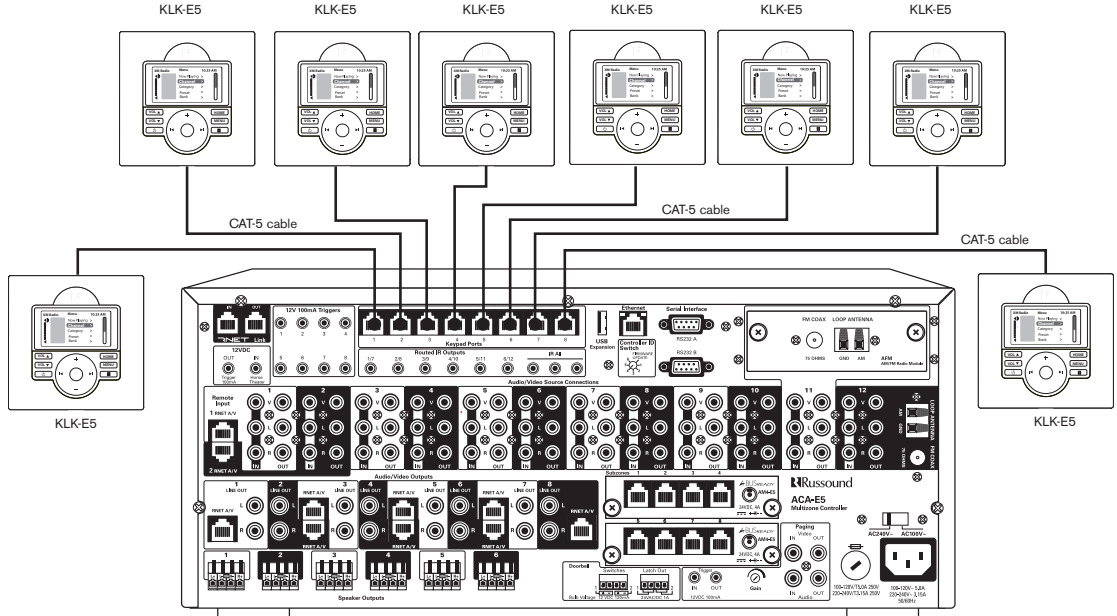

KLK-E5 REAR PANEL AUX CONNECTION

The KLK-E5 keypad has an AUX auxiliary input for daisy-chaining one more KLK-E5 keypad. The additional keypad in the daisy chain will have the same keypad ID number and zone properties as the first keypad in the chain.

Connections are made using CAT-5 cable and RJ45 connectors with T568A wiring standard. Cable length from the last keypad in the chain back to the controller should be no more that 250 feet.

NOTE: Do NOT connect an UNO-TS2 touch-screen to the AUX connection.

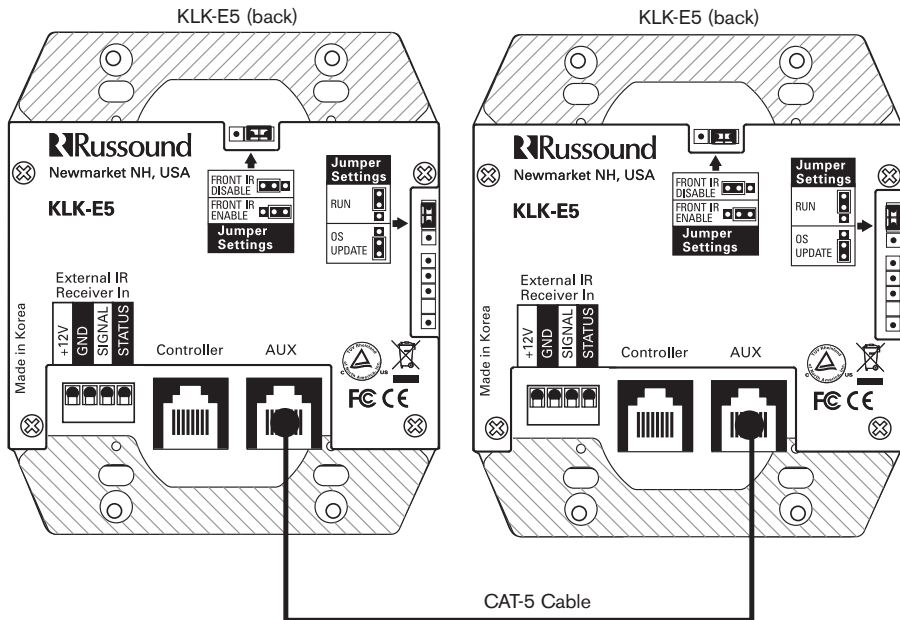

KLK-E5 NAVIGATION AND MENUS

The KLK-E5 has buttons and a click touch wheel to find and control music and video, and to make changes to system settings and room audio levels.

Six backlit buttons access power on/off, music pause, volume up/down and menu shortcuts. A select button in the center of the click wheel activates

a menu choice, and the touch wheel provides the scrolling action through menus and lists. All music/video sources, audio adjustments and system settings are arranged in menus and lists.

The keypad's home screen, buttons and navigation wheel are described below.

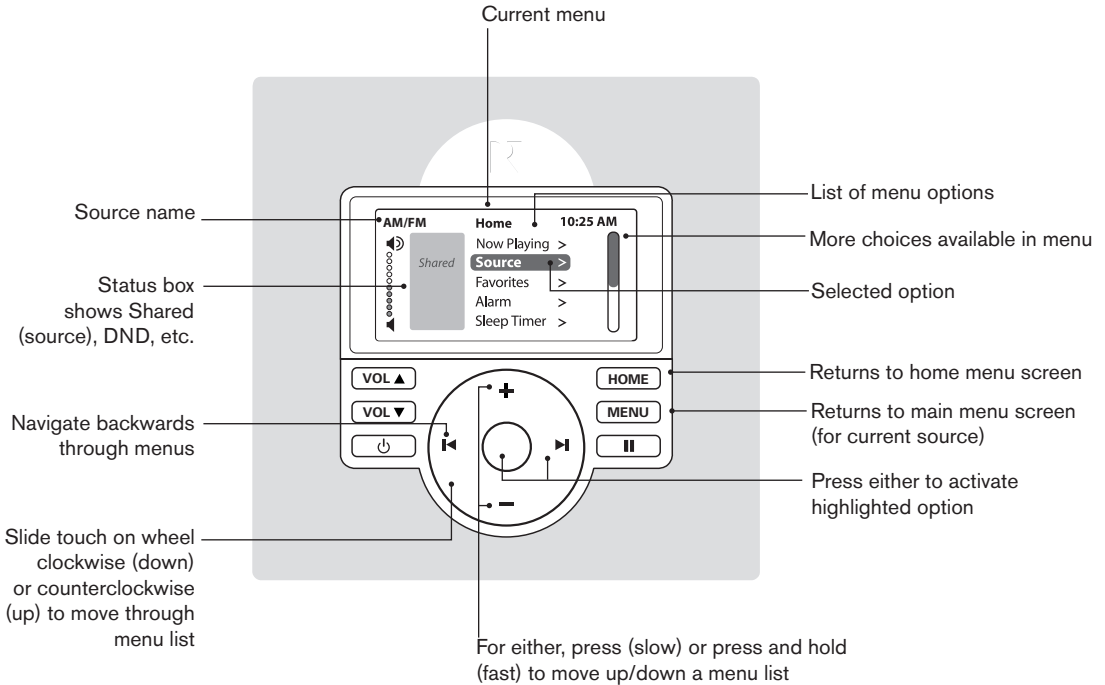

The clock format, time and date for the system is set through the KLK-E5.

Clock Format

From the home menu, select “Settings,” then “Clock.” Choose “Clock Format,” and select 12 hour (AM/PM) or 24 hour (1200) format.

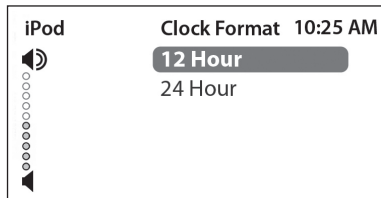

Set Date

From the Clock menu, select “Set Date.” The date format is month/day/year. Scroll with the touch wheel, or press the wheel’s + and -- to move through numbers. Press next and previous on the wheel to move the cursor, and press select to save.

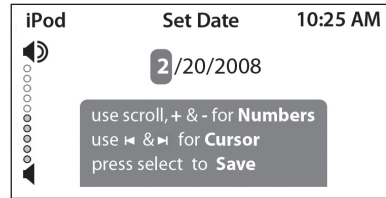

Set Time

From the Clock menu, select “Set Time.” Scroll with the touch wheel, or press the wheel’s + and - to move through numbers. Press next and previous on the wheel to move the cursor, and press select to save.

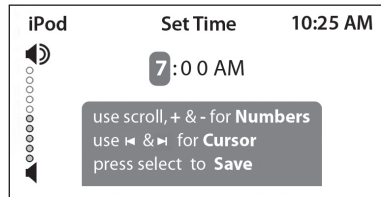

AUTHORIZE SUPPORT FOR ACA-E5 SYSTEM

The KLK-E5 provides the portal to a support tunnel when an installer needs Russound's help troubleshooting an ACA-E5 system.

From the main menu, select "Settings," then "Installation." Choose "Authorize Support." On the Authorize support screen, select "On." A session number will be provided in the Session Number box.

During the support tunnel process, the system is unavailable for use.

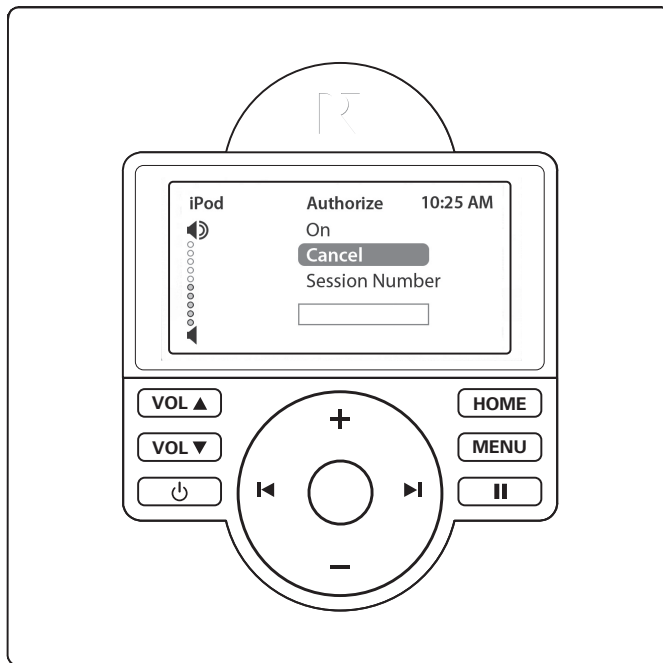

Technical Specifications

| | |
|-------------------------|---|
| Power requirements | 275mA @ 12VDC MAX |
| CAT-5 connection | RJ45 (T568A standard) |
| Display | 70 mm W x 35 mm H high resolution LCD |
| Controls | Round capacitive touch ring scroll interface Six backlit hard buttons |
| Wall surface dimensions | 4.5"W x 4.5"H (11.43 x 11.43 cm) |
| Inside box dimensions | 3.5"W x 1.5"D x 2.75"H (8.9 x 3.8 x 6.9 cm) |
| Weight | 1 lbs. (0.45 kg) |

Warranty

Russound sells E-Series products through Russound Sphere Certified Integrators to ensure customers obtain quality pre-sale and after-sale support and service. Russound does not authorize internet, telephone or mail order sales of Russound E-Series products to consumers. The sale to consumers of any Russound E-Series product on the Internet or by telephone or mail order shall void the Russound E-Series warranty on the applicable product; and any Russound E-Series product purchased from an unauthorized dealer or source, including any Internet retailer or telephone or mail order seller, will not be honored or serviced under any Russound warranty.

The warranty on Russound E-Series products is NOT VALID if the products have been purchased on the Internet, by telephone or mail order, or from an unauthorized dealer. **PROTECT YOUR WARRANTY.** Buy only from a Russound Sphere Certified integrator. If you have questions about a dealer or reseller, contact Russound Sales at 866.604.5245

The Russound E-Series KLK-E5 product is fully guaranteed against defects in materials and workmanship for three (3) years from the date of purchase. During this

period, Russound will replace any defective parts and correct any defect in workmanship without charge for either parts or labor.

For this warranty to apply, the unit must be installed and serviced by a Russound Sphere Certified Integrator and used in accordance with written instructions. If service becomes necessary, please contact your local Russound Sphere Certified Integrator to arrange for product return.

This Warranty does not cover:

- Damage caused by abuse, accident, misuse, negligence, or improper installation or operation
- Power surges and lightning strikes
- Normal wear and maintenance
- Products that have been altered or modified
- Any product whose identifying number, decal, serial number, etc. has been altered, defaced or removed

Products out of warranty will be subject to a minimum repair estimate. All repairs will be made on the basis of the retail value of the parts and labor. All service is to be performed by Russound.

Russound Sphere Certified Integrator Instructions:

Prior to returning a unit for repair, contact Russound at (866) 604.5245 to obtain a Return Authorization Number. Reference this RA# number on all correspondence and outer shipping label.

Ship to:

Russound

ATTN: E-Series Priority Service
5 Forbes Road
Newmarket, NH 03857

It is recommended that the product be packaged in a corrugated container with a minimum of three (3) inches of resilient material to protect the unit from damage during transit. Accidental damage and shipping damage are not considered defects.



SPHERE™

E-Series

Installation Manual

©2008 Russound. All rights reserved.
All trademarks are the property of their respective owners.
Specifications are subject to change without notice. Russound is not responsible for typographical errors or omissions.

Russound, Inc.
5 Forbes Road, Newmarket, NH 03857
tel 866.604.5245 • fax 603.292.8352
www.russoundsphere.com
28-1281 04/01/08

Click Wheel Keypad
KLK-E5

Premier products for Russound
Sphere™ Certified Professionals

Russound®